

Basic-type Digital Temperature Controller

E5AN/E5EN (96 x 96 mm and 48 x 96 mm)

New 96 x 96-mm and 48 x 96-mm Basic Temperature Controllers with Enhanced Functions and Performance. Improved Indication Accuracy and Preventive Maintenance Function.

- Indication Accuracy
 - Thermocouple input: $\pm 0.3\%$ of PV (previous models: $\pm 0.5\%$)
 - Pt input: $\pm 0.2\%$ of PV (previous models: $\pm 0.5\%$)
 - Analog input: $\pm 0.2\%$ FS (previous models: $\pm 0.5\%$)
- A PV/SV-status display function can be set to automatically alternate between displaying the status of the Temperature Controller (auto/manual, RUN/STOP, and alarms) and the PV or SV.
- Preventive maintenance for relays in the Temperature Controller using a Control Output ON/OFF Counter.
- Three-level display that simultaneously displays the PV, SV, and MV.
- One-touch operation with PF Key that can be assigned to auto/manual, RUN/STOP, or other functions.



96 x 96 mm
E5AN

48 x 96 mm
E5EN

NEW

Refer to *Safety Precautions* on page 66.

Main I/O Functions

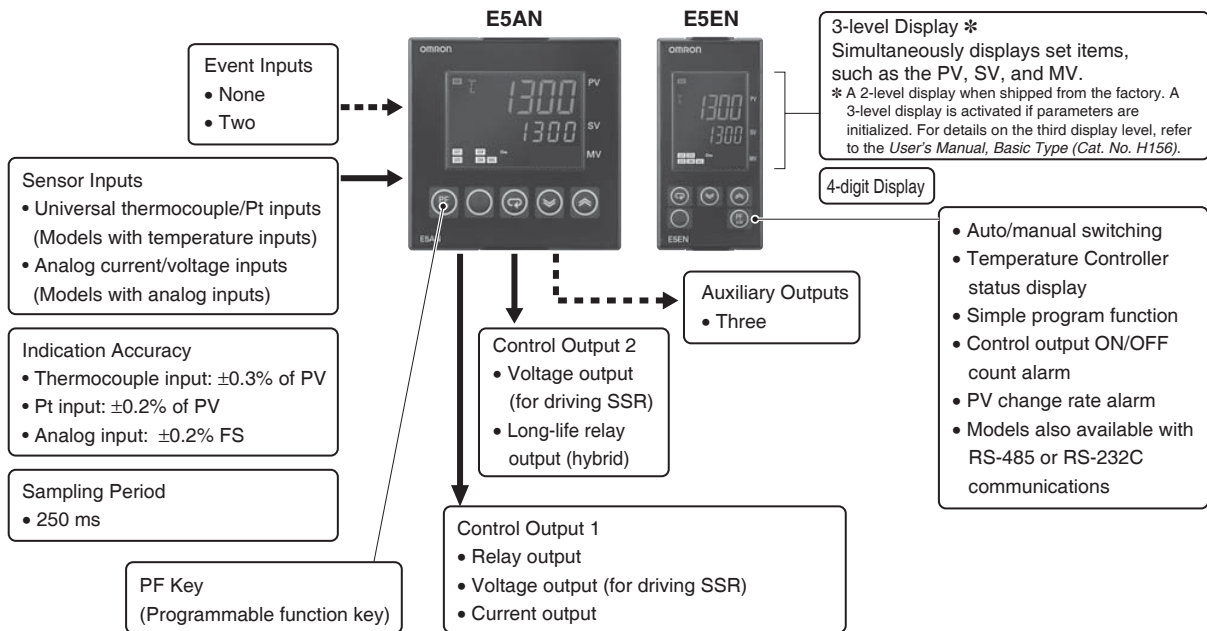

This data sheet is provided as a guideline for selecting products. Be sure to refer to the following user manuals for application precautions and other information required for operation before attempting to use the product.

E5CN/E5AN/E5EN Digital Temperature Controllers User's Manual Basic Type (Cat. No. H156)

E5CN/E5AN/E5EN Digital Temperature Controllers Communications Manual Basic Type (Cat. No. H158)

E5CN
E5CN-U (48 x 48 mm)

E5AN (96 x 96 mm)
E5EN (48 x 96 mm)

E5CN-H (48 x 48 mm)

E5AN-H (96 x 96 mm)
E5EN-H (48 x 96 mm)

Operation

Safety Precautions

E5AN/E5EN

Lineup

E5CN
E5CN-U (48 x 48 mm)

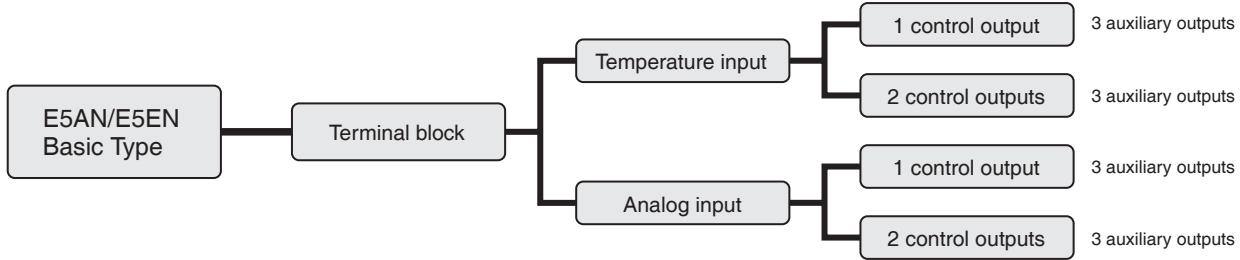

E5AN (96 x 96 mm)
E5EN (48 x 96 mm)

Note: Models with one control output or two control outputs can be used for heating/cooling control.

Model Number Structure

Model Number Legend

Controllers

E5AN/E5EN- 3 M - 500-N
1 2 3 4 5 6 7 8 9

- 1. Control Output 1**
 R: Relay output
 Q: Voltage output (for driving SSR)
 C: Current output
- 2. Auxiliary Outputs**
 3: Three outputs
- 3. Heater Burnout/SSR Failure, Control Output 2, or External Power Supply for ES1B**
 Blank: None
 Q: Control output 2 (voltage output for driving SSR)
 Y: Long-life relay output (hybrid)
 H: Heater burnout/SSR failure/Heater overcurrent detection (CT1)
 HH: Heater burnout/SSR failure/Heater overcurrent detection (CT2)
 P: Power supply for sensor
- 4. Option**
 M: Option Unit can be mounted.
- 5. Input Type**
 T: Universal thermocouple/platinum resistance thermometer input
 L: Analog current/voltage input
- 6. Power Supply Voltage**
 Blank: 100 to 240 VAC
 D: 24 VAC/VDC
- 7. Case Color**
 Blank: Black
 W: Silver
- 8. Terminal Cover**
 -500: With terminal cover
- 9. Version**
 N: Available only to models released after January 2008.

Option Units

E53-
1

- 1. Function**
 EN01: RS-232C communications
 EN03: RS-485 communications
 AKB: Event input

E5CN-H (48 x 48 mm)

E5AN-H (96 x 96 mm)
E5EN-H (48 x 96 mm)

Operation

Safety Precautions

Ordering Information

E5AN
Controllers with Terminal Blocks

Size	Case color	Power supply voltage	Input type	Auxiliary outputs	Control output 1	Functions			Model					
						Heater burnout	Power supply for Sensor	Control output 2						
1/4 DIN 96 × 96 × 78 (W × H × D)	Black	100 to 240 VAC	Thermocouple or Resistance thermometer	3	Relay output				E5AN-R3MT-500-N					
					Voltage output (for driving SSR)				E5AN-Q3MT-500-N					
					Current output				E5AN-C3MT-500-N					
					Relay output	1			E5AN-R3HMT-500-N					
					Voltage output (for driving SSR)	1			E5AN-Q3HMT-500-N					
					Relay output	2			E5AN-R3HHMT-500-N					
					Voltage output (for driving SSR)	2			E5AN-Q3HHMT-500-N					
					Relay output			Voltage output	E5AN-R3QMT-500-N					
					Voltage output (for driving SSR)			Voltage output	E5AN-Q3QMT-500-N					
					Current output			Voltage output	E5AN-C3QMT-500-N					
					Relay output			Long-life relay output	E5AN-R3YMT-500-N					
					Voltage output (for driving SSR)				E5AN-Q3YMT-500-N					
					Current output				E5AN-C3YMT-500-N					
					Relay output		Sensor Power		E5AN-R3PMT-500-N					
					Voltage output (for driving SSR)		Sensor Power		E5AN-Q3PMT-500-N					
					24 VAC/VDC	Silver	24 VAC/VDC	Thermocouple or Resistance thermometer	3	Relay output				E5AN-R3ML-500-N
										Voltage output (for driving SSR)				E5AN-Q3ML-500-N
										Current output				E5AN-C3ML-500-N
	Relay output	1								E5AN-R3HML-500-N				
	Voltage output (for driving SSR)	1								E5AN-Q3HML-500-N				
	Voltage output (for driving SSR)			Long-life relay output						E5AN-Q3YML-500-N				
	100 to 240 VAC	Silver	24 VAC/VDC	Thermocouple or Resistance thermometer	3	Relay output				E5AN-R3MTD-500-N				
						Voltage output (for driving SSR)				E5AN-Q3MTD-500-N				
						Current output				E5AN-C3MTD-500-N				
Relay output						1			E5AN-R3HMTD-500-N					
Voltage output (for driving SSR)						1			E5AN-Q3HMTD-500-N					
Relay output						2			E5AN-R3HHMTD-500-N					
Voltage output (for driving SSR)	2			E5AN-Q3HHMTD-500-N										
100 to 240 VAC	Silver	24 VAC/VDC	Thermocouple or Resistance thermometer	3	Relay output				E5AN-R3MT-W-500-N					
					Voltage output (for driving SSR)				E5AN-Q3MT-W-500-N					
					Current output				E5AN-C3MT-W-500-N					
					Relay output	1			E5AN-R3HMT-W-500-N					
					Voltage output (for driving SSR)	1			E5AN-Q3HMT-W-500-N					
					Relay output				E5AN-R3MTD-W-500-N					
Voltage output (for driving SSR)				E5AN-Q3MTD-W-500-N										
Current output				E5AN-C3MTD-W-500-N										

E5CN
E5CN-U (48 x 48 mm)

E5AN (96 x 96 mm)
E5EN (48 x 96 mm)

E5CN-H (48 x 48 mm)

E5AN-H (96 x 96 mm)
E5EN-H (48 x 96 mm)

Operation

Safety Precautions

E5AN/E5EN

E5CN
E5CN-U (48 x 48 mm)

E5AN (96 x 96 mm)
E5EN (48 x 96 mm)

E5CN-H (48 x 48 mm)

E5AN-H (96 x 96 mm)
E5EN-H (48 x 96 mm)

Operation

Safety Precautions

E5EN Controllers with Terminal Blocks

Size	Case color	Power supply voltage	Input type	Auxiliary outputs	Control output 1	Functions			Model				
						Heater burnout	Power supply for Sensor	Control output 2					
1/8 DIN 48 × 96 × 78 (W × H × D)	Black	100 to 240 VAC	Thermocouple or Resistance thermometer	3	Relay output				E5EN-R3MT-500-N				
					Voltage output (for driving SSR)				E5EN-Q3MT-500-N				
					Current output				E5EN-C3MT-500-N				
					Relay output	1			E5EN-R3HMT-500-N				
					Voltage output (for driving SSR)	1			E5EN-Q3HMT-500-N				
					Relay output	2			E5EN-R3HHMT-500-N				
					Voltage output (for driving SSR)	2			E5EN-Q3HHMT-500-N				
					Relay output			Voltage output	E5EN-R3QMT-500-N				
					Voltage output (for driving SSR)			Voltage output	E5EN-Q3QMT-500-N				
					Current output			Voltage output	E5EN-C3QMT-500-N				
					Relay output			Long-life relay output	E5EN-R3YMT-500-N				
					Voltage output (for driving SSR)			Long-life relay output	E5EN-Q3YMT-500-N				
					Current output			Long-life relay output	E5EN-C3YMT-500-N				
					Relay output		Sensor Power		E5EN-R3PMT-500-N				
					Voltage output (for driving SSR)		Sensor Power		E5EN-Q3PMT-500-N				
					Analog (current/voltage)	3	3	Relay output					E5EN-R3ML-500-N
								Voltage output (for driving SSR)				E5EN-Q3ML-500-N	
								Current output				E5EN-C3ML-500-N	
	Relay output	1						E5EN-R3HML-500-N					
	Voltage output (for driving SSR)	1						E5EN-Q3HML-500-N					
	Relay output			Long-life relay output				E5EN-R3YML-500-N					
	24 VAC/VDC	3	Thermocouple or Resistance thermometer	Relay output					E5EN-R3MTD-500-N				
				Voltage output (for driving SSR)				E5EN-Q3MTD-500-N					
				Current output				E5EN-C3MTD-500-N					
Relay output				1			E5EN-R3HMTD-500-N						
Voltage output (for driving SSR)				1			E5EN-Q3HMTD-500-N						
Relay output				2			E5EN-R3HHMTD-500-N						
Voltage output (for driving SSR)	2			E5EN-Q3HHMTD-500-N									
100 to 240 VAC	3	Thermocouple or Resistance thermometer	Relay output					E5EN-R3MT-W-500-N					
			Voltage output (for driving SSR)				E5EN-Q3MT-W-500-N						
			Current output				E5EN-C3MT-W-500-N						
			Relay output	1			E5EN-R3HMT-W-500-N						
			Voltage output (for driving SSR)	1			E5EN-Q3HMT-W-500-N						
			Relay output				E5EN-R3MTD-W-500-N						
24 VAC/VDC	3	Thermocouple or Resistance thermometer	Voltage output (for driving SSR)					E5EN-Q3MTD-W-500-N					
			Current output				E5EN-C3MTD-W-500-N						
			Relay output				E5EN-R3MTD-W-500-N						

Option Units

Name	Function	Model
Communications Unit	RS-232C communications	E53-EN01
	RS-485 communications	E53-EN03
Event Input Unit	Event inputs	E53-AKB

Accessories (Order Separately)

USB-Serial Conversion Cable

Model
E58-CIFQ1

Terminal Cover

Connectable models	Model
E5AN	E53-COV16
E5EN	

Note: The Terminal Cover comes with the E5CN-□□□-500 models.

Waterproof Packing

Connectable models	Model
E5AN	Y92S-P4
E5EN	Y92S-P5

Note: The Waterproof Packing is included with the Controller.

Current Transformers (CTs)

Hole diameter	Model
5.8 dia.	E54-CT1
12.0 dia.	E54-CT3

CX-Thermo Support Software

Model
EST2-2C-MV4

E5CN
E5CN-U (48 x 48 mm)

E5AN (96 x 96 mm)
E5EN (48 x 96 mm)

E5CN-H (48 x 48 mm)

E5AN-H (96 x 96 mm)
E5EN-H (48 x 96 mm)

Operation

Safety Precautions

E5AN/E5EN

Specifications

Ratings

Power supply voltage		No D in model number: 100 to 240 VAC, 50/60 Hz D in model number: 24 VAC, 50/60 Hz; 24 VDC
Operating voltage range		85% to 110% of rated supply voltage
Power consumption		100 to 240 VAC: 10 VA 24 VAC/VDC: 5.5 VA (24 VAC)/4 W (24 VDC)
Sensor input		Models with temperature inputs Thermocouple: K, J, T, E, L, U, N, R, S, B, W, or PL II Platinum resistance thermometer: Pt100 or JPt100 Infrared temperature sensor: 10 to 70°C, 60 to 120°C, 115 to 165°C, or 140 to 260°C Voltage input: 0 to 50 mV
		Models with analog inputs Current input: 4 to 20 mA or 0 to 20 mA Voltage input: 1 to 5 V, 0 to 5 V, or 0 to 10 V
Input impedance		Current input: 150 Ω max., Voltage input: 1 MΩ min. (Use a 1:1 connection when connecting the ES2-HB.)
Control method		ON/OFF control or 2-PID control (with auto-tuning)
Control output	Relay output	SPST-NO, 250 VAC, 5 A (resistive load), electrical life: 100,000 operations, minimum applicable load: 5 V, 10 mA
	Voltage output (for driving SSR)	Output voltage: 12 VDC ±15% (PNP), max. load current: 40 mA, With short-circuit protection circuit: Max. load current of 21 mA for control output 2
	Current output	4 to 20 mA DC/0 to 20 mA DC, load: 600 Ω max., resolution: approx. 10,000
	Long-life relay output	SPST-NO, 250 VAC, 3 A (resistive load), electrical life: 1,000,000 operations, load power supply voltage: 75 to 250 VAC (DC loads cannot be connected.), minimum applicable load: 5 V, 10 mA, leakage current: 5 mA max. (250 VAC, 60 Hz)
Auxiliary output	Number of outputs	3
	Output specifications	Relay output: SPST-NO, 250 VAC, 3 A (resistive load), electrical life: 100,000 operations, minimum applicable load: 5 V, 10 mA
Event input	Number of inputs	2
	External contact input specifications	Contact input: ON: 1 kΩ max., OFF: 100 kΩ min. Non-contact input: ON: Residual voltage: 1.5 V max., OFF: Leakage current: 0.1 mA max. Current flow: Approx. 7 mA per contact
External power supply for ES1B		12 VDC ±10%, 20 mA, short-circuit protection circuit provided
Setting method		Digital setting using front panel keys
Indication method		11-segment digital display and individual indicators (7-segments displays also possible) Character height: E5AN: PV: 15.8 mm, SV: 9.5 mm, MV: 6.8 mm; E5EN: PV: 11.8 mm, SV: 8.1 mm, MV: 5.8 mm Content of 3-level display: PV/SV/MV, PV/SV/multi-SP, or soak time remain * Number of digits: 4 for PV, SV, and MV
Multi SP		Up to four set points (SP0 to SP3) can be saved and selected using event inputs, key operations, or serial communications.
Bank switching		Not supported.
Other functions		Manual output, heating/cooling control, loop burnout alarm, SP ramp, other alarm functions, heater burnout detection, 40% AT, 100% AT, MV limiter, input digital filter, self-tuning, temperature input shift, run/stop, protection functions, control output ON/OFF counter, extraction of square root, MV change rate limit, logic operations, PV/SV status display, simple program, automatic cooling coefficient adjustment
Ambient operating temperature		-10 to 55°C (with no condensation or icing), for 3-year warranty: -10 to 50°C
Ambient operating humidity		25% to 85%
Storage temperature		-25 to 65°C (with no condensation or icing)

* A 2-level display when shipped from the factory. A 3-level display is activated if parameters are initialized. For details on the third display level, refer to the *User's Manual, Basic Type* (Cat. No. H156).

E5CN
E5CN-U (48 x 48 mm)

E5AN (96 x 96 mm)
E5EN (48 x 96 mm)

E5CN-H (48 x 48 mm)

E5AN-H (96 x 96 mm)
E5EN-H (48 x 96 mm)

Operation

Safety Precautions

Input Ranges

Thermocouple/Platinum Resistance Thermometer (Universal inputs)

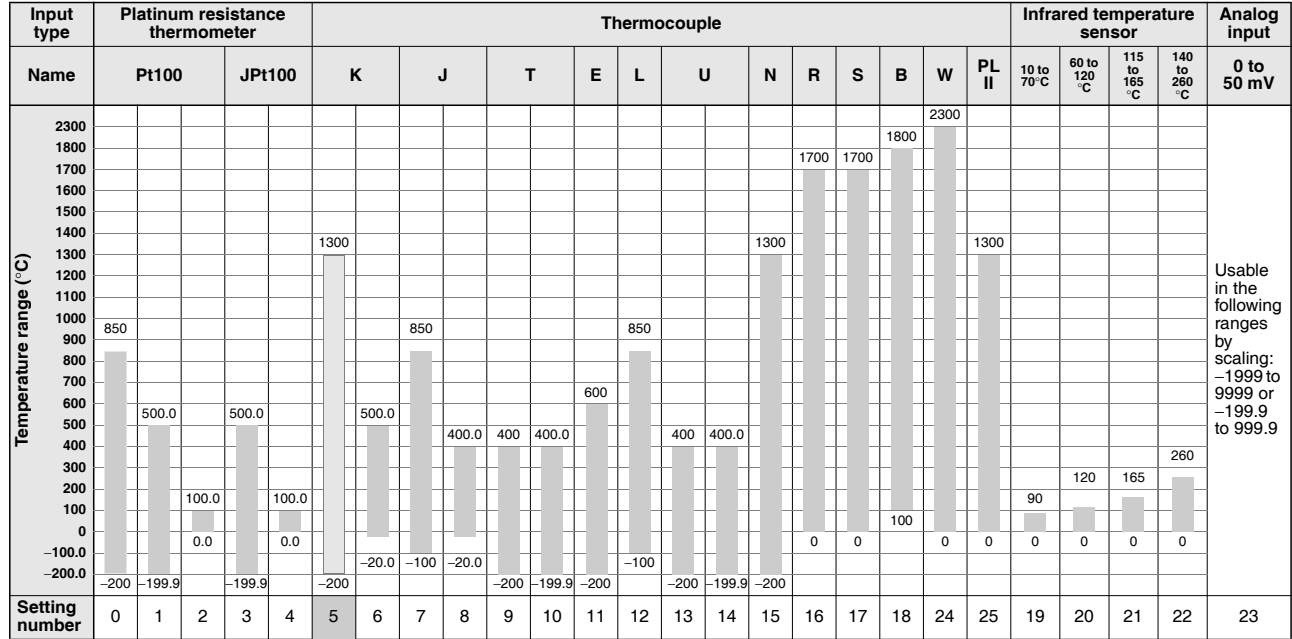

Shaded settings are the default settings.

The applicable standards for the input types are as follows:

K, J, T, E, N, R, S, B: JIS C 1602-1995, IEC 584-1

L: Fe-CuNi, DIN 43710-1985

U: Cu-CuNi, DIN 43710-1985

W: W5Re/W26Re, ASTM E988-1990

JPt100: JIS C 1604-1989, JIS C 1606-1989

Pt100: JIS C 1604-1997, IEC 751

PL II: According to Platinel II electromotive force charts from BASF (previously Engelhard)

Models with Analog Inputs

Input type	Current		Voltage		
Input specification	4 to 20mA	0 to 20 mA	1 to 5 V	0 to 5 V	0 to 10 V
Setting range	Usable in the following ranges by scaling: -1999 to 9999, -199.9 to 999.9, -19.99 to 99.99 or -1.999 to 9.999				
Setting number	0	1	2	3	4

Shaded settings are the default settings.

E5CN
E5CN-U (48 x 48 mm)

E5AN (96 x 96 mm)
E5EN (48 x 96 mm)

E5CN-H (48 x 48 mm)

E5AN-H (96 x 96 mm)
E5EN-H (48 x 96 mm)

Operation

Safety Precautions

Alarm Outputs

Each alarm can be independently set to one of the following 13 alarm types. The default is 2: *Upper limit*. Auxiliary outputs are allocated for alarms. ON delays and OFF delays (0 to 999 s) can also be specified.

Note: For models with heater burnout, SSR failure, and heater overcurrent detection, alarm 1 will be an OR output of the alarm selected from the following alarm types and the alarms for heater burnout, SSR failure, and heater overcurrent. To output only a heater burnout alarm, SSR failure alarm, and heater overcurrent alarm for alarm 1, set the alarm type to 0 (i.e., no alarm function).

Set value	Alarm type	Alarm output operation	
		When X is positive	When X is negative
0	Alarm function OFF	Output OFF	
1 *1	Upper- and lower-limit		*2
2	Upper limit		
3	Lower limit		
4 *1	Upper- and lower-limit range		*3
5 *1	Upper- and lower-limit with standby sequence		*4
6	Upper-limit with standby sequence		
7	Lower-limit with standby sequence		
8	Absolute-value upper-limit		
9	Absolute-value lower-limit		
10	Absolute-value upper-limit with standby sequence		
11	Absolute-value lower-limit with standby sequence		
12	LBA (for alarm 1 only)	---	---
13	PV change rate alarm	---	---

*1. With set values 1, 4 and 5, the upper and lower limit values can be set independently for each alarm type, and are expressed as "L" and "H."

*2. Set value: 1, Upper- and lower-limit alarm

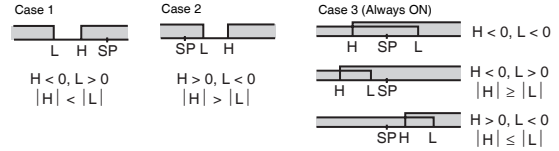

*3. Set value: 4, Upper- and lower-limit range

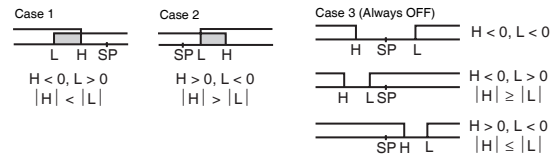

*4. Set value: 5, Upper- and lower-limit with standby sequence
For Upper- and Lower-Limit Alarm Described Above

- Case 1 and 2
Always OFF when the upper-limit and lower-limit hysteresis overlaps.
- Case 3: Always OFF

*5. Set value: 5, Upper- and lower-limit with standby sequence
Always OFF when the upper-limit and lower-limit hysteresis overlaps.

Characteristics

Indication accuracy	Thermocouple: ($\pm 0.3\%$ of indicated value or $\pm 1^\circ\text{C}$, whichever is greater) ± 1 digit max. *1 Platinum resistance thermometer: ($\pm 0.2\%$ of indicated value or $\pm 0.8^\circ\text{C}$, whichever is greater) ± 1 digit max. Analog input: $\pm 0.2\%$ FS ± 1 digit max. CT input: $\pm 5\%$ FS ± 1 digit max.
Transfer output accuracy	$\pm 0.3\%$ FS max.
Influence of temperature *2	Thermocouple input (R, S, B, W, PL II): ($\pm 1\%$ of PV or $\pm 10^\circ\text{C}$, whichever is greater) ± 1 digit max. Other thermocouple input: ($\pm 1\%$ of PV or $\pm 4^\circ\text{C}$, whichever is greater) ± 1 digit max. *3 Platinum resistance thermometer: ($\pm 1\%$ of PV or $\pm 2^\circ\text{C}$, whichever is greater) ± 1 digit max.
Influence of voltage *2	Analog input: ($\pm 1\%$ FS) ± 1 digit max.
Input sampling period	250 ms
Hysteresis	Models with thermocouple/platinum resistance thermometer input (universal input): 0.1 to 999.9 EU (in units of 0.1 EU) *4 Models with analog input: 0.01 to 99.99% FS (in units of 0.01% FS)
Proportional band (P)	Models with thermocouple/platinum resistance thermometer input (universal input): 0.1 to 999.9 EU (in units of 0.1 EU) *4 Models with analog input: 0.1 to 999.9% FS (in units of 0.1% FS)
Integral time (I)	0 to 3999 s (in units of 1 s)
Derivative time (D)	0 to 3999 s (in units of 1 s) *5
Control period	0.5, 1 to 99 s (in units of 1 s)
Manual reset value	0.0 to 100.0% (in units of 0.1%)
Alarm setting range	-1999 to 9999 (decimal point position depends on input type)
Affect of signal source resistance	Thermocouple: $0.1^\circ\text{C}/\Omega$ max. (100 Ω max.) Platinum resistance thermometer: $0.1^\circ\text{C}/\Omega$ max. (10 Ω max.)
Insulation resistance	20 M Ω min. (at 500 VDC)
Dielectric strength	2,300 VAC, 50 or 60 Hz for 1 min (between terminals with different charge)
Vibration resistance	Malfunction 10 to 55 Hz, 20 m/s ² for 10 min each in X, Y, and Z directions Destruction 10 to 55 Hz, 0.75-mm single amplitude for 2 hrs each in X, Y, and Z directions
Shock resistance	Malfunction 100 m/s ² , 3 times each in X, Y, and Z directions Destruction 300 m/s ² , 3 times each in X, Y, and Z directions
Weight	E5AN Controller: Approx. 310 g, Mounting Bracket: Approx. 100 g E5EN Controller: Approx. 260 g, Mounting Bracket: Approx. 100 g
Degree of protection	Front panel: IP66, Rear case: IP20, Terminals: IP00
Memory protection	Non-volatile memory (number of writes: 1,000,000 times)
Setup Tool	CX-Thermo version 4.0 or higher
Setup Tool port	Provided on the bottom of the E5AN and E5EN. An E58-CIFQ1 USB-Serial Conversion Cable is required to connect the computer to the E5AN and E5EN *6
Standards	Approved standards UL 61010-1, CSA C22.2 No. 1010-1 Conformed standards EN 61010-1 (IEC 61010-1): Pollution level 2, overcurrent category II
EMC	EMI: EN 61326 Radiated Interference Electromagnetic Field Strength: EN 55011 Group 1, class A Noise Terminal Voltage: EN 55011 Group 1, class A EMS: EN 61326 ESD Immunity: EN 61000-4-2 Electromagnetic Field Immunity: EN 61000-4-3 Burst Noise Immunity: EN 61000-4-4 Conducted Disturbance Immunity: EN 61000-4-6 Surge Immunity: EN 61000-4-5 Power Frequency Magnetic Field Immunity: EN 61000-4-8 Voltage Dip/Interrupting Immunity: EN 61000-4-11

*1. The indication accuracy of K thermocouples in the -200 to 1300°C range, T and N thermocouples at a temperature of -100°C max., and U and L thermocouples at any temperatures is $\pm 2^\circ\text{C} \pm 1$ digit max. The indication accuracy of the B thermocouple at a temperature of 400°C max. is not specified. The indication accuracy of B thermocouples in the 400 to 800°C range is $\pm 3^\circ\text{C}$ max. The indication accuracy of the R and S thermocouples at a temperature of 200°C max. is $\pm 3^\circ\text{C} \pm 1$ digit max. The indication accuracy of W thermocouples is ± 0.3 of PV or $\pm 3^\circ\text{C}$, whichever is greater, ± 1 digit max. The indication accuracy of PL II thermocouples is ± 0.3 of PV or $\pm 2^\circ\text{C}$, whichever is greater, ± 1 digit max.

*2. Ambient temperature: -10°C to 23°C to 55° , Voltage range: -15% to 10% of rated voltage

*3. K thermocouple at -100°C max.: $\pm 10^\circ\text{C}$ max.

*4. "EU" stands for Engineering Unit and is used as the unit after scaling. For a temperature sensor, the EU is $^\circ\text{C}$ or $^\circ\text{F}$.

*5. When robust tuning (RT) is ON, the differential time is 0.0 to 999.9 (in units of 0.1 s).

*6. External communications (RS-232C or RS-485) and cable communications for the Setup Tool can be used at the same time.

E5CN
E5CN-U (48 x 48 mm)E5AN (96 x 96 mm)
E5EN (48 x 96 mm)

E5CN-H (48 x 48 mm)

E5AN-H (96 x 96 mm)
E5EN-H (48 x 96 mm)

Operation

Safety Precautions

E5AN/E5EN

E5CN
E5CN-U (48 x 48 mm)

USB-Serial Conversion Cable

Applicable OS	Windows 2000, XP, or Vista
Applicable software	Thermo Mini, CX-Thermo version 4.0 or higher
Applicable models	E5AN/E5EN/E5CN/E5CN-U/E5AN-H/E5EN-H/E5CN-H
USB interface standard	Conforms to USB Specification 1.1.
DTE speed	38400 bps
Connector specifications	Computer: USB (type A plug) Temperature Controller: Setup Tool port (on bottom of Controller)
Power supply	Bus power (Supplied from USB host controller.)
Power supply voltage	5 VDC
Current consumption	70 mA
Ambient operating temperature	0 to 55°C (with no condensation or icing)
Ambient operating humidity	10% to 80%
Storage temperature	-20 to 60°C (with no condensation or icing)
Storage humidity	10% to 80%
Altitude	2,000 m max.
Weight	Approx. 100 g

Note: A driver must be installed in the personal computer. Refer to installation information in the operation manual for the Conversion Cable.

E5AN (96 x 96 mm)
E5EN (48 x 96 mm)

E5CN-H (48 x 48 mm)

Communications Specifications

Transmission line connection method	RS-485: Multipoint RS-232C: Point-to-point
Communications	RS-485 (two-wire, half duplex) or RS-232C
Synchronization method	Start-stop synchronization
Protocol	CompoWay/F, SYSWAY, or Modbus
Baud rate	1200, 2400, 4800, 9600, 19200, 38400, or 57600 bps
Transmission code	ASCII
Data bit length *	7 or 8 bits
Stop bit length *	1 or 2 bits
Error detection	Vertical parity (none, even, odd) Frame check sequence (FCS) with SYSWAY Block check character (BCC) with CompoWay/F or CRC-16 Modbus
Flow control	None
Interface	RS-485, RS-232C
Retry function	None
Communications buffer	217 bytes
Communications response wait time	0 to 99 ms Default: 20 ms

* The baud rate, data bit length, stop bit length, and vertical parity can be individually set using the Communications Setting Level.

E5AN-H (96 x 96 mm)
E5EN-H (48 x 96 mm)

Operation

Safety Precautions

Current Transformer (Order Separately) Ratings

Dielectric strength	1,000 VAC for 1 min
Vibration resistance	50 Hz, 98 m/s ²
Weight	E54-CT1: Approx. 11.5 g, E54-CT3: Approx. 50 g
Accessories (E54-CT3 only)	Armatures (2) Plugs (2)

Heater Burnout Alarms, SSR Failure Alarms, and Heater Overcurrent Alarms

CT input (for heater current detection)	Models with detection for single-phase heaters: One input Models with detection for single-phase or three-phase heaters: Two inputs
Maximum heater current	50 A AC
Input current indication accuracy	±5% FS ±1 digit max.
Heater burnout alarm setting range *1	0.1 to 49.9 A (in units of 0.1 A) Minimum detection ON time: 100 ms
SSR failure alarm setting range *2	0.1 to 49.9 A (in units of 0.1 A) Minimum detection OFF time: 100 ms
Heater overcurrent alarm setting range *3	0.1 to 49.9 A (in units of 0.1 A) Minimum detection ON time: 100 ms

- *1. For heater burnout alarms, the heater current will be measured when the control output is ON, and the output assigned to the alarm 1 function will turn ON if the heater current is lower than the set value (i.e., heater burnout detection current value).
- *2. For SSR failure alarms, the heater current will be measured when the control output is OFF, and the output assigned to the alarm 1 function will turn ON if the heater current is higher than the set value (i.e., SSR failure detection current value).
- *3. For heater overcurrent alarms, the heater current will be measured when the control output is ON, and the output assigned to the alarm 1 function will turn ON if the heater current is higher than the set value (i.e., heater overcurrent detection current value).

Electrical Life Expectancy Curve for Relays (Reference Values)

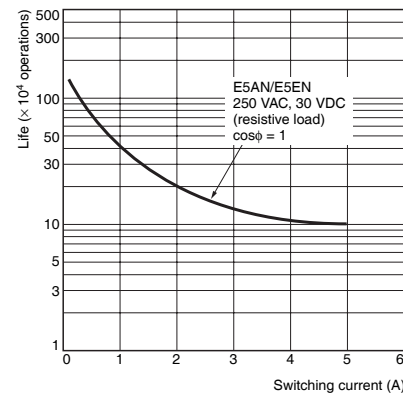

Note: Do not connect a DC load to a Controller with a Long-life Relay Output.

External Connections

- A voltage output (control output 1, for driving SSR) is not electrically insulated from the internal circuits. When using a grounding thermocouple, do not connect any of the control output terminals to ground. If the control output terminals are connected to ground, errors will occur in the measured temperature values as a result of leakage current.
The voltage output (control output 2, for driving SSR) has basic insulation provided for the internal circuit.
- Consult with your OMRON representative before using the external power supply for the ES1B for any other purpose.

Controllers

- 100 to 240 VAC
- 24 VAC/VDC (no polarity)

Control output 1

Relay output
250 VAC, 5A
(resistive load)
Voltage output
(for driving SSR)
12 VDC, 40 mA
Current output
0 to 20 mA DC
4 to 20 mA DC
Load: 600 Ω max.

Control output 2

Voltage output
(for driving SSR)
12 VDC, 21 mA
Long-life relay output
250 VAC, 3 A
(resistive load)

**Auxiliary output
1, 2, 3**

Relay outputs
250 VAC, 3 A
(resistive load)

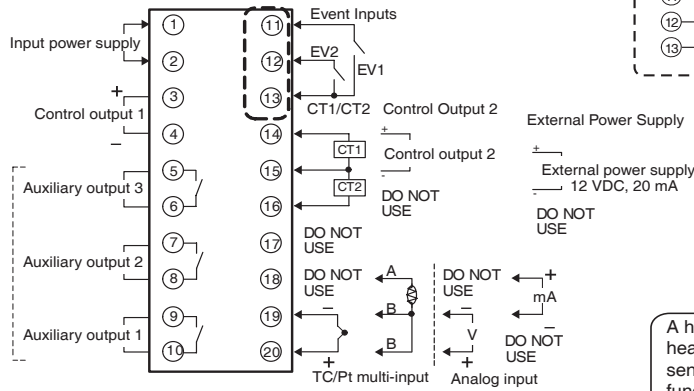

Option Units

Communications		
E53-EN01 RS-232C	E53-EN03 RS-485	E53-AKB Event inputs
⑪—SD	⑪—B (+)	⑪—EV1
⑫—RD	⑫—A (-)	⑫—EV2
⑬—SG	⑬—DO NOT USE	⑬—CT1/CT2

A heater burnout alarm, heater short alarm, heater overcurrent alarm, or input alarm is sent to the output to which the alarm 1 function is assigned.

E5CN
E5CN-U (48 x 48 mm)

E5AN (96 x 96 mm)
E5EN (48 x 96 mm)

E5CN-H (48 x 48 mm)

E5AN-H (96 x 96 mm)
E5EN-H (48 x 96 mm)

Operation

Safety Precautions

E5AN/E5EN

Nomenclature

E5CN
E5CN-U (48 x 48 mm)

E5AN (96 x 96 mm)
E5EN (48 x 96 mm)

E5AN

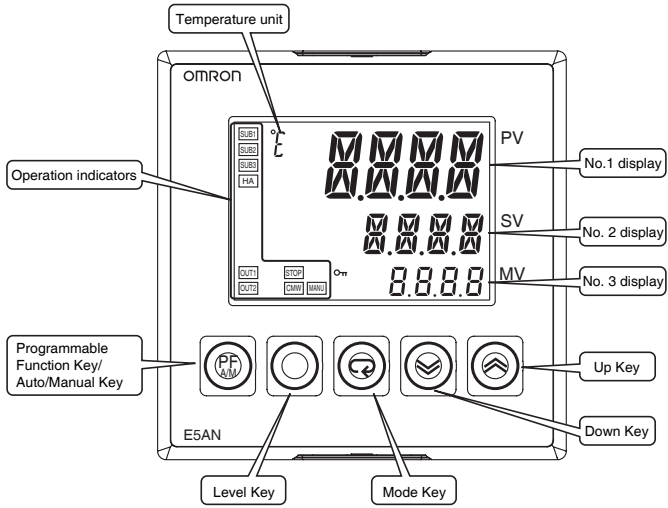

E5EN

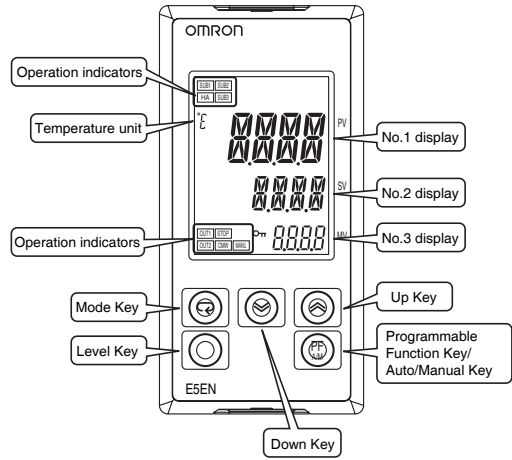

* A 2-level display when shipped from the factory. A 3-level display is activated if parameters are initialized. For details on the third display level, refer to the *User's Manual, Basic Type* (Cat. No. H156).

Dimensions

(Unit: mm)

E5CN-H (48 x 48 mm)

E5AN



E5AN-H (96 x 96 mm)
E5EN-H (48 x 96 mm)

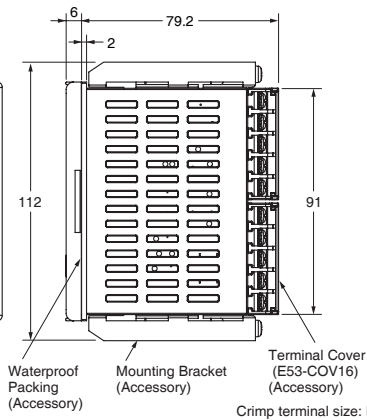
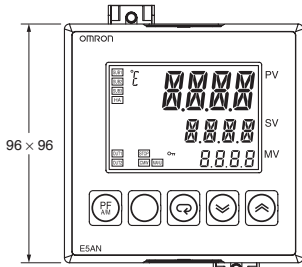

Mounted Separately

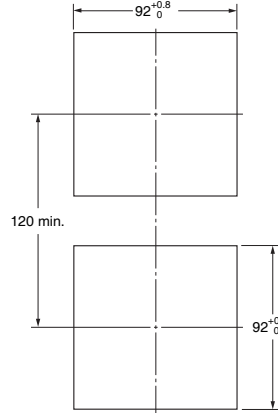

Group Mounted

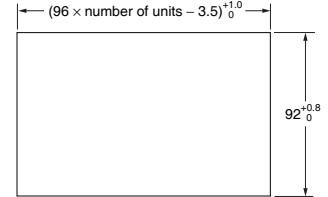

Group mounting does not allow waterproofing.

- Recommended panel thickness is 1 to 8 mm.
- Group mounting is not possible in the vertical direction. (Maintain the specified mounting space between Controllers.)
- To mount the Controller so that it is waterproof, insert the waterproof packing onto the Controller.
- When two or more Controllers are mounted, make sure that the surrounding temperature does not exceed the allowable operating temperature specified in the specifications.

Operation

Safety Precautions

E5EN

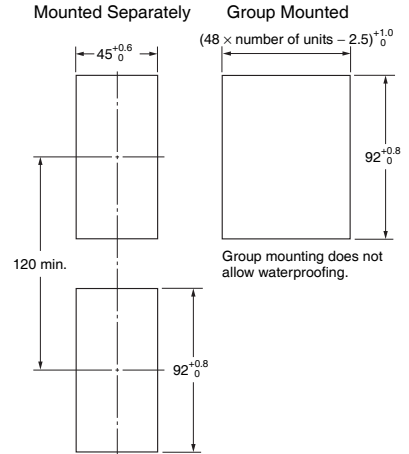
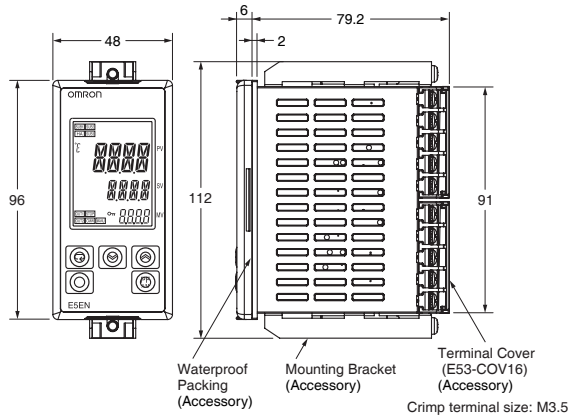

- Recommended panel thickness is 1 to 8 mm.
- Group mounting is not possible in the vertical direction. (Maintain the specified mounting space between Controllers.)
- To mount the Controller so that it is waterproof, insert the waterproof packing onto the Controller.
- When two or more Controllers are mounted, make sure that the surrounding temperature does not exceed the allowable operating temperature specified in the specifications.

E5CN
E5CN-U (48 x 48 mm)

E5AN (96 x 96 mm)
E5EN (48 x 96 mm)

E5CN-H (48 x 48 mm)

E5AN-H (96 x 96 mm)
E5EN-H (48 x 96 mm)

Operation

Safety Precautions

Accessories (Order Separately)

USB-Serial Conversion Cable E58-CIFQ1

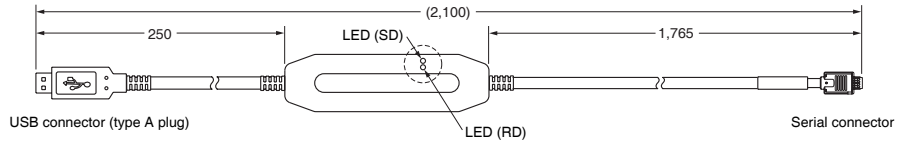
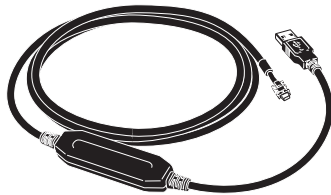

Terminal Covers

E53-COV16 (Six Covers provided.)

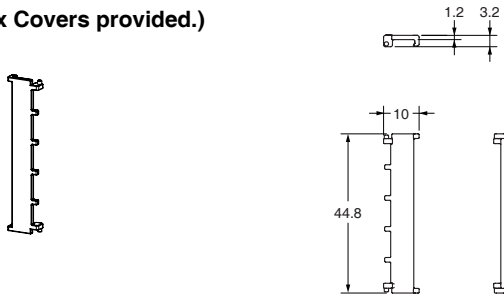

E5AN/E5EN

E5CN
E5CN-U (48 x 48 mm)

E5AN (96 x 96 mm)
E5EN (48 x 96 mm)

E5CN-H (48 x 48 mm)

E5AN-H (96 x 96 mm)
E5EN-H (48 x 96 mm)

Operation

Safety Precautions

Waterproof Packing

Y92S-P4 (for DIN 96 × 96)

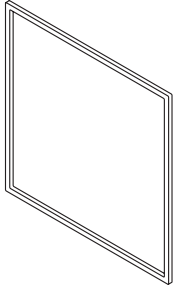

Y92S-P5 (for DIN 48 × 96)

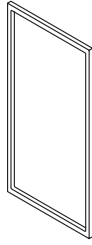

Order the Waterproof Packing separately if it becomes lost or damaged.
The Waterproof Packing can be used to achieve an IP66 degree of protection.
(Deterioration, shrinking, or hardening of the waterproof packing may occur depending on the operating environment. Therefore, periodic replacement is recommended to ensure the level of waterproofing specified in IP66. The time for periodic replacement depends on the operating environment. Be sure to confirm this point at your site. Consider one year a rough standard. OMRON shall not be liable for the level of water resistance if the customer does not perform periodic replacement.)
The Waterproof Packing does not need to be attached if a waterproof structure is not required.

Current Transformers

E54-CT1

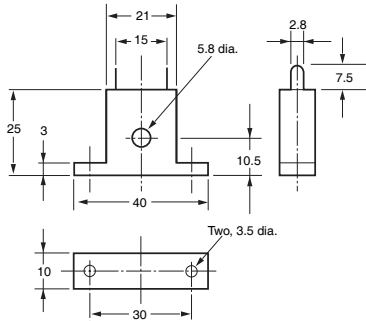
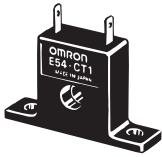

E54-CT1

Thru-current (Io) vs. Output Voltage (Eo) (Reference Values)

Maximum continuous heater current: 50 A (50/60 Hz)
Number of windings: 400±2
Winding resistance: 18±2 Ω

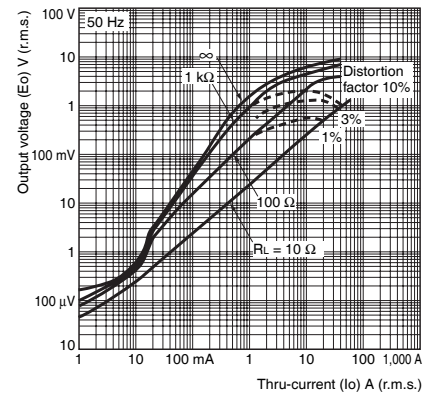

E54-CT3

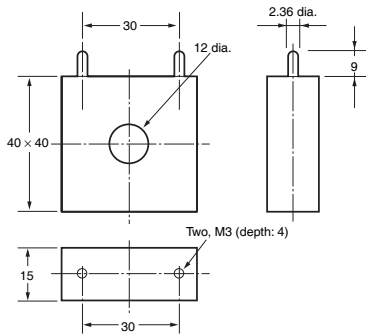

E54-CT3

Thru-current (Io) vs. Output Voltage (Eo) (Reference Values)

Maximum continuous heater current: 120 A (50/60 Hz)
(Maximum continuous heater current for an OMRON Temperature Controller is 50 A.)
Number of windings: 400±2
Winding resistance: 8±0.8 Ω

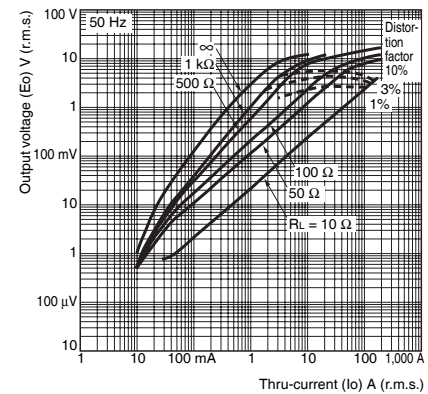

E54-CT3 Accessory

- Armature

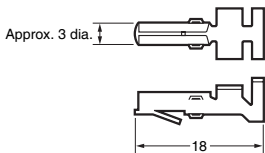

- Plug

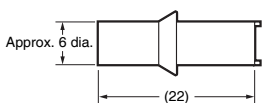

Connection Example

